

1 LEVER 2 FUNCTIONS  
NEW TECHNOLOGY



## THERMOSTATIC & FLOW CONTROL WITH ONE HAND

The VT40 is **the only product that combines all the advantages of thermostatics into one single lever cartridge**. This innovating product is a concentration of expertise and is made with high quality materials. It finally enables thermostatic technology to be used with one hand in every place where there is water!

### ADVANTAGES

#### / 2 IN 1 EASY USE

One faucet handle to control both the temperature and the flow rate

#### / TEMPERATURE STABILITY

Regulation of the temperature remains stable in case of any pressure variation

#### / SAVINGS

The thermostatic technology enables optimized water and energy consumption

#### / INTERCHANGEABILITY

**Standard size 40mm** to replace any mechanical standard single lever cartridge

#### / SAFETY

- antiscald security in case of cold-water failure
- no intercommunication hazards

#### / FRIENDLY MIXER DESIGN

Easy integration  
Compact size

### APPLICATIONS



Washbasin



Shower



Bidet



Kitchen sink

### QUALITY & CERTIFICATIONS

100% quality control: each cartridge is individually checked for leakage and antiscald function

Materials are certified to drinkable water regulation requirements

# SINGLE LEVER THERMOSTATIC CARTRIDGE VT40SL

## TECHNICAL PERFORMANCES

### GENERAL CHARACTERISTICS

**Thermal regulation** complies with the EN1111 requirement.

**Flow rate** value at more than 16 l/min in a shower application at 38°C.

**Endurance** validated in a Vernet valve body.

### — ANGLE VS TEMPERATURE

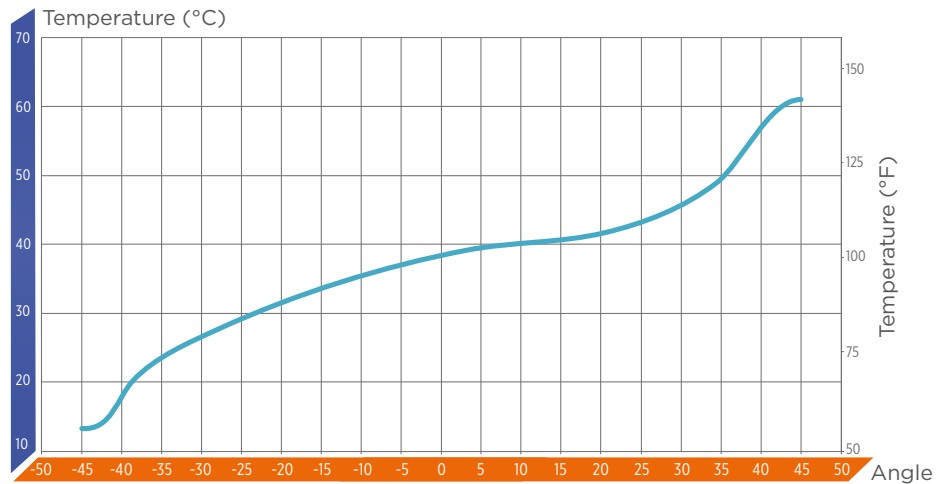

### DIMENSIONS (in mm)

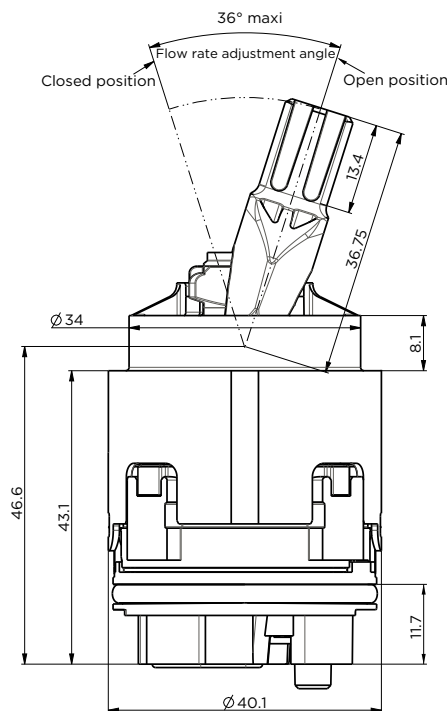

### HOUSING RECOMMENDATION (in mm)

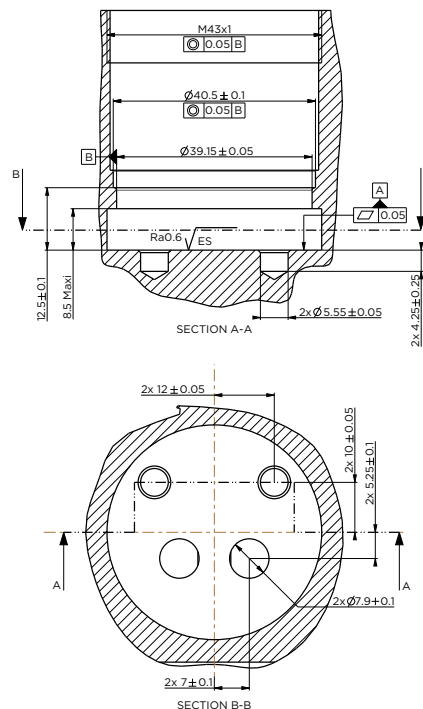

Technical drawings are available on request



[www.vernet.fr](http://www.vernet.fr)

21-27 route d'Arpajon - BP 31 Ollainville - 91291 Arpajon cedex - France

Tel. + 33 (0) 1 69 26 82 82 - Fax + 33 (0) 1 60 83 03 03

For more information: [s-hvac@vernet.fr](mailto:s-hvac@vernet.fr)